

Módulos Práticos I  
Módulos Max  
Módulos Prático  
Tabela de Peso e Índice de Perfis

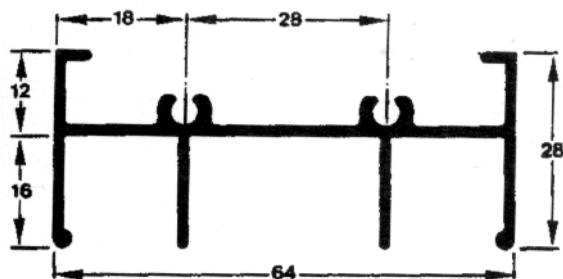

**MP-357**  
0.659 Kg/m  
Marco Superior

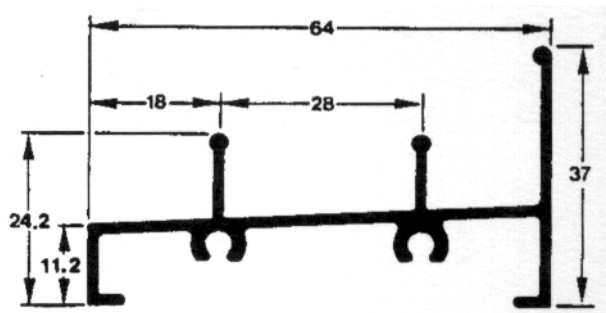

**MP-358**  
0.631 Kg/m  
Marco Inferior

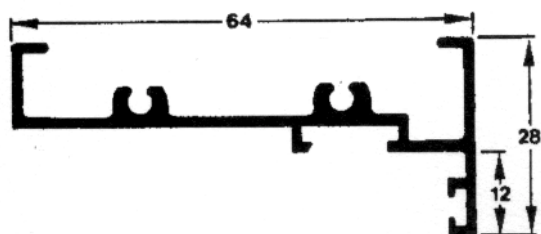

**MP-363**  
0.539 Kg/m  
Marco

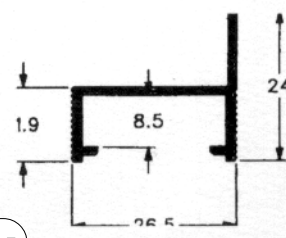

**CM-063**  
0,220 Kg/m

Contramarco

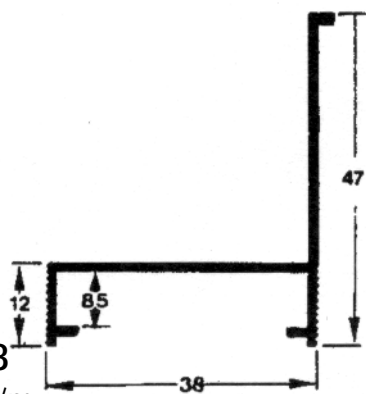

**CM-098**  
0.387 Kg/m  
Contramarco

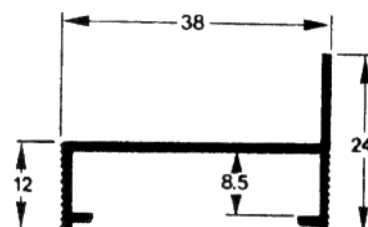

**CM-060**  
0.280 Kg/m  
Contramarco

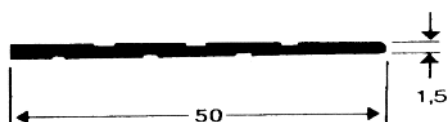

**CL-011**  
0,305 Kg/m

Cunha de Conexão

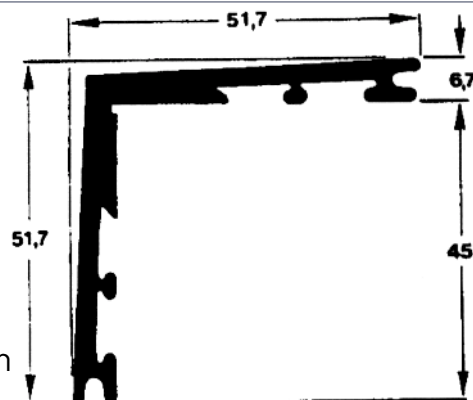

**CL-006**  
1,053 Kg/m

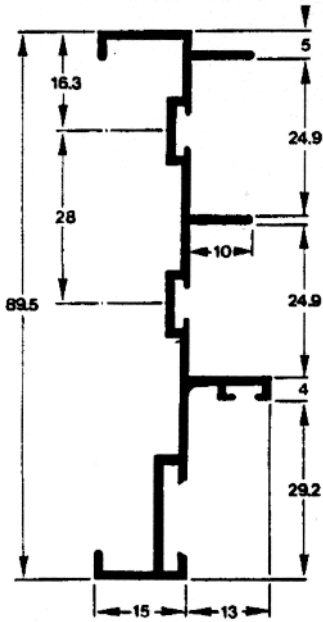

**MP-345**  
0.710 Kg/m  
Marco Lateral

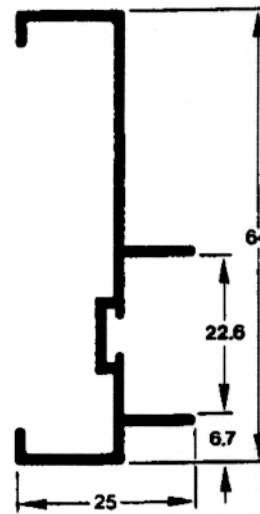

**MP-360**  
0,442 Kg/m  
Marco Lateral/Porta e Janela

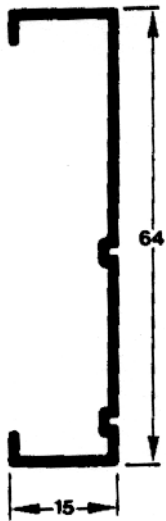

**MP-359**  
0.363 Kg/m  
Marco Lateral para  
Bandeira

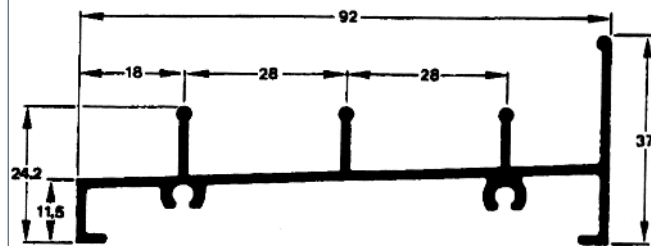

**MP-367**  
0.818 Kg/m  
Marco Inferior

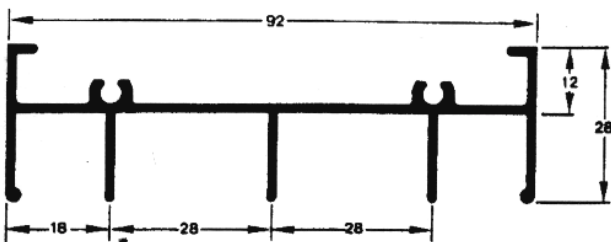

**MP-366**  
0,865 Kg/m  
Marco Superior

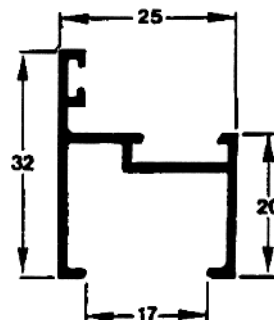

Marco 90°



**25-311**  
0,300 Kg/m

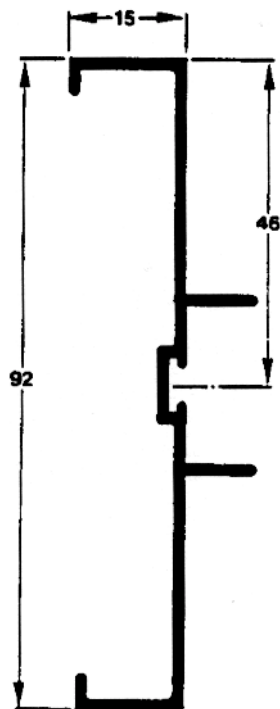

**MP-369**  
0.588 Kg/m  
Montante Lateral

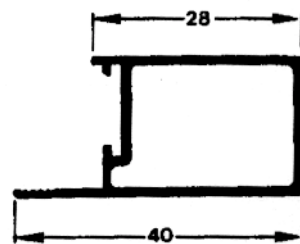

**MP-300**  
0.369 Kg/m

Montante Vertical

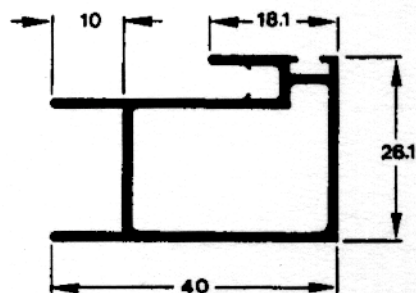

**MP-303**  
0.474 Kg/m  
Montante com engate  
Veneziana

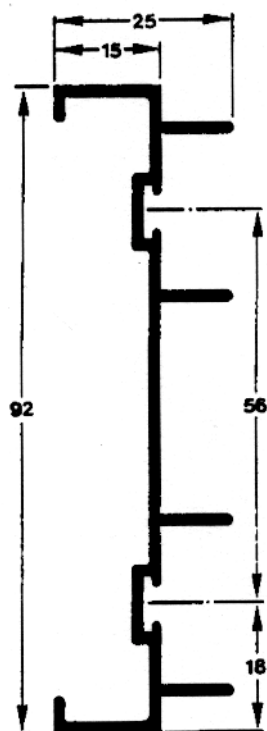

**MP-368**  
0.683 Kg/m

Montante Lateral

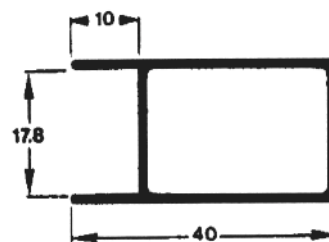

**MP-305**  
0.393 Kg/m  
Montante Vertical  
Veneziana

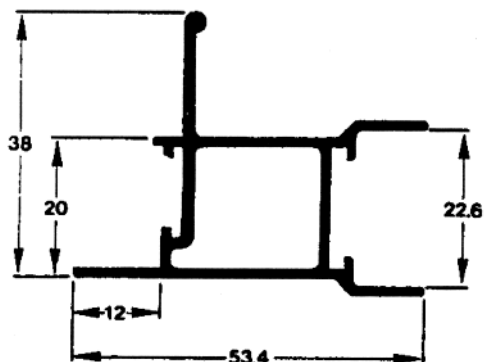

Montante  
Central



**MP-374**  
0.569 Kg/m

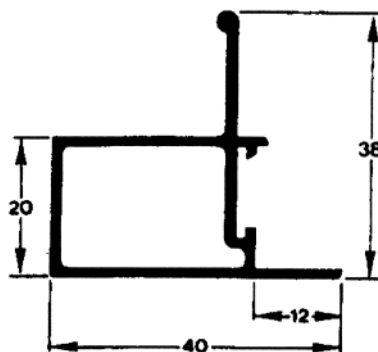

**MP-372**  
0.452 Kg/m  
Montante Central

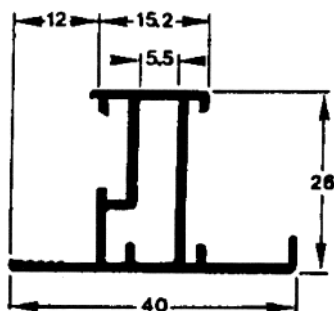

**MM-375/25304**  
0,417 Kg/m  
Montante folha  
90° e 45°

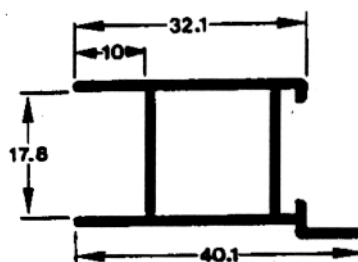

**ME-071**  
0.368 Kg/m  
Montante Camarão

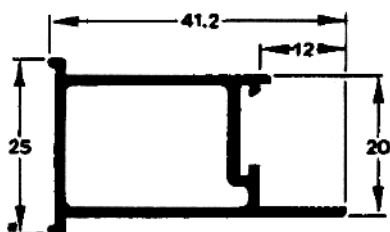

**MP-373**  
0,392 Kg/m  
Montante folha fixa

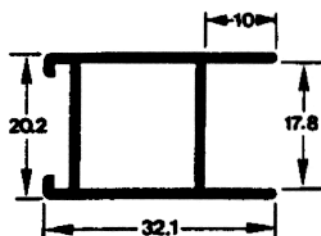

**ME-072**  
0,322 Kg/m  
Montante Camarão



**ME-072**  
0,322 Kg/m

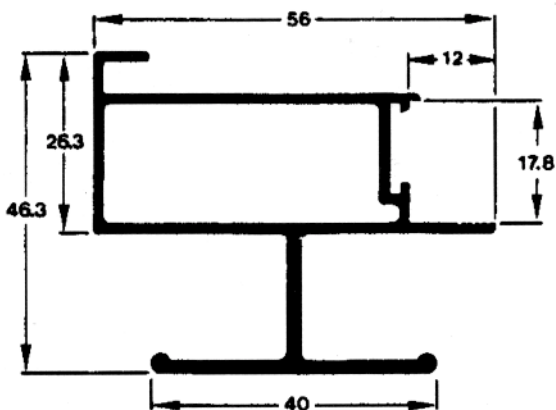

**MP-380**

0.905 Kg/m

Montante com engate e Puxador

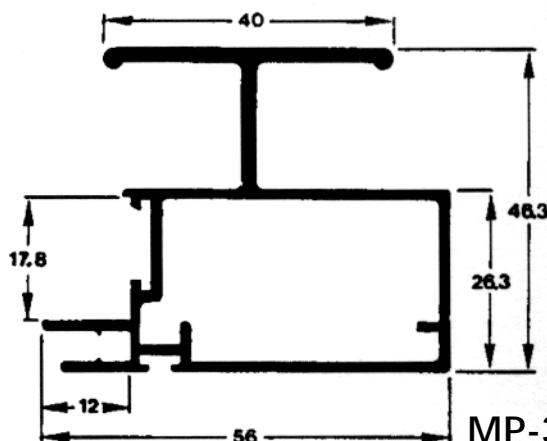

**MP-379**

0.975 Kg/m

Montante com engate e puxador para Porta

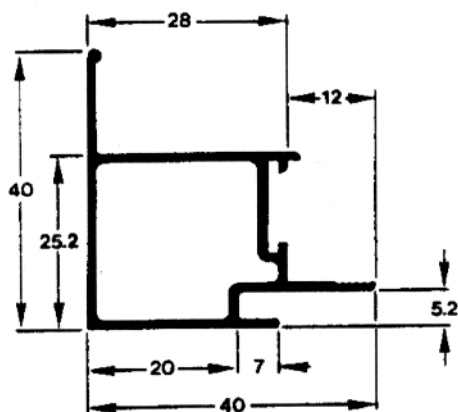

**MP-321**

0,417 Kg/m

Montante Vertical com engate e puxador

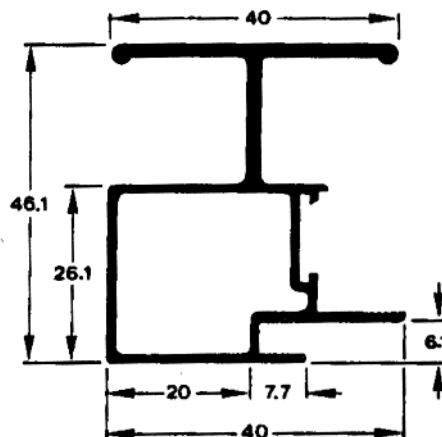

**MP-381**

0.750 Kg/m

Montante Vertical com engate e puxador

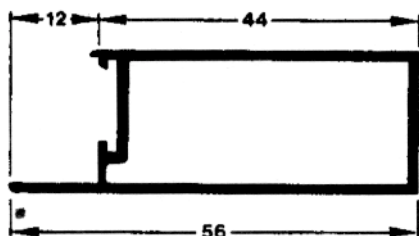

**MP-336**

0,474 Kg/m

Montante Vertical Porta

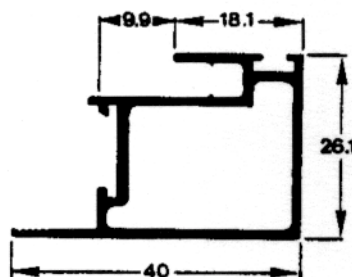

**MP-302**

0,450 Kg/m

Montante Vertical com engate

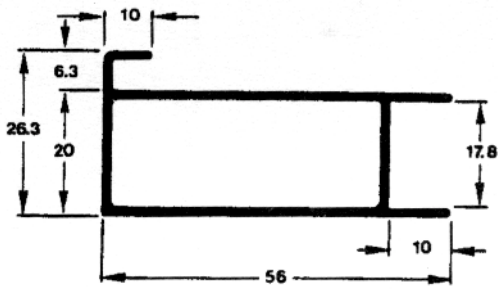

**MP-383**

0,589 Kg/m

Montante Vertical Porta

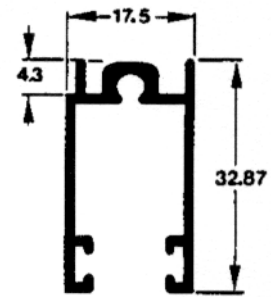

**MP-378**

0.357 Kg/m

Montante Veneziana

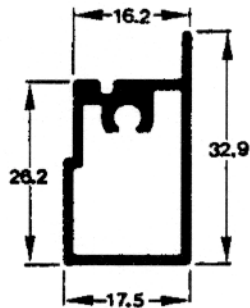

**ME-070**

0.363 Kg/m

Montante Horizontal

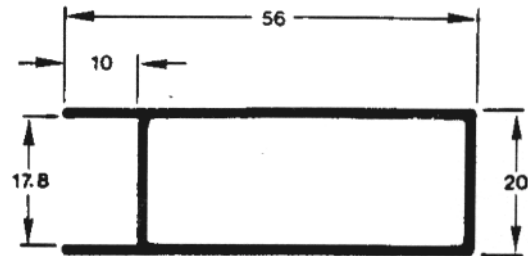

**MP-382**

0,541 Kg/m

Montante Vertical  
Porta

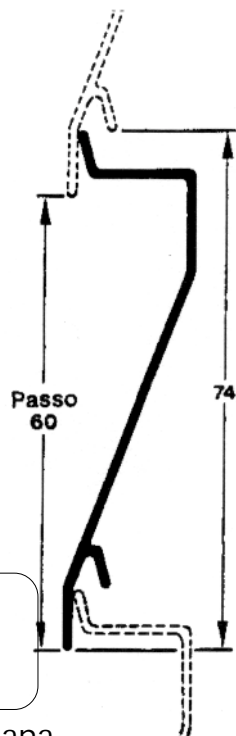

**VZ-023**

0,293 Kg/m

Palheta para Veneziana

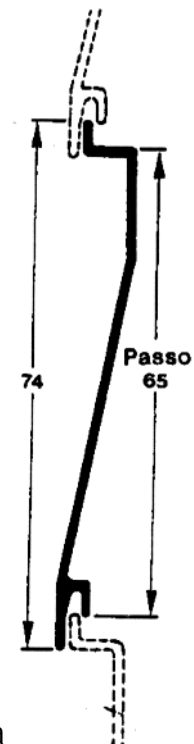

**VZ-024**

0,271 Kg/m

Palheta para Veneziana

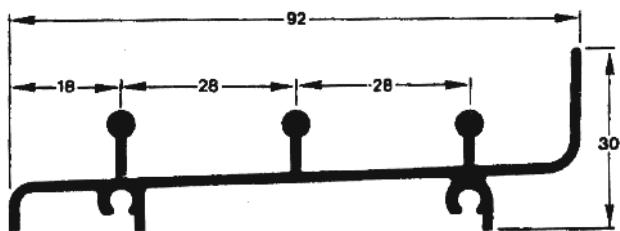

**MP-371**

0,818 Kg/m

Trilho da Porta

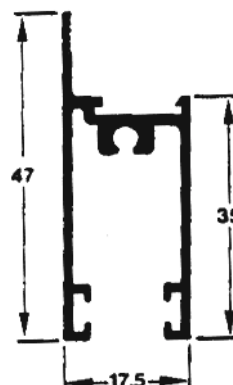

**MP-309**

0,429 Kg/m

Montante Horizontal  
Inferior e Superior

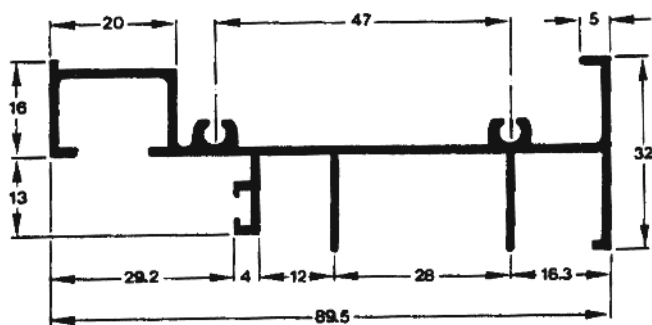

**MP-344**

0.986 Kg/m

Guia Superior

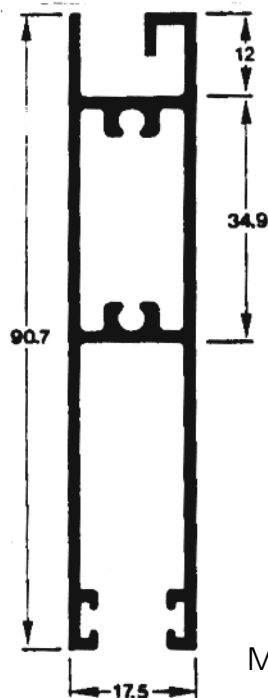

**MP-354**

0,980 Kg/m

Montante Horizontal  
Inferior da Porta

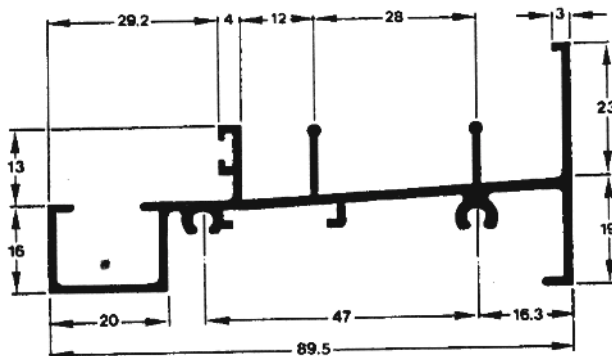

**MP-346**

1.060 Kg/m

Peitoral 2 trilhos

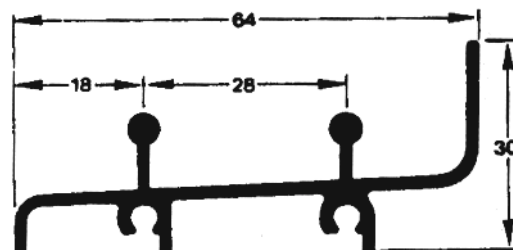

**MP-370**

0.642 Kg/m

Trilho da Porta



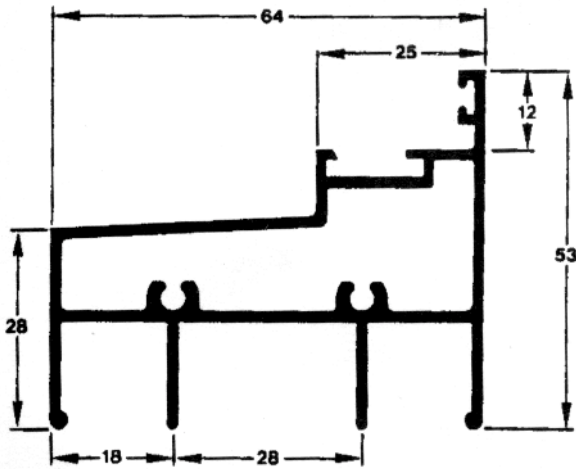

**MP-361**

1.078 Kg/m

Travessa para  
Bandeira

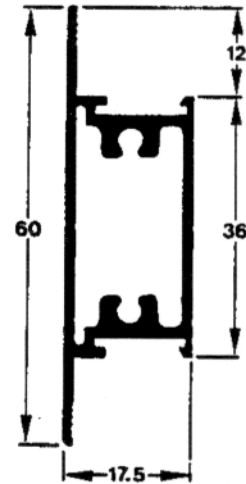

**MP-332**

0,616 Kg/m

Travessa para Porta

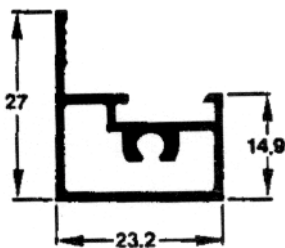

**25-301**

0,350 Kg/m

Superior Folha 90°

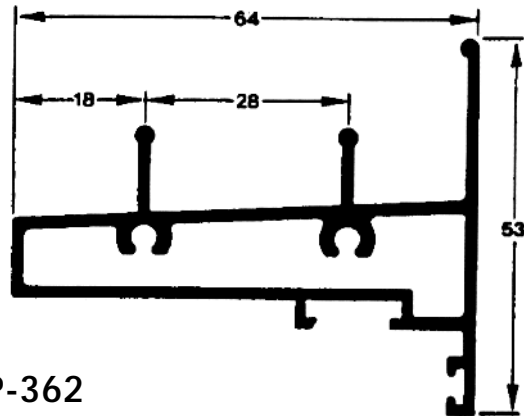

**MP-362**

0,983 Kg/m

Travessa para bandeira inferior

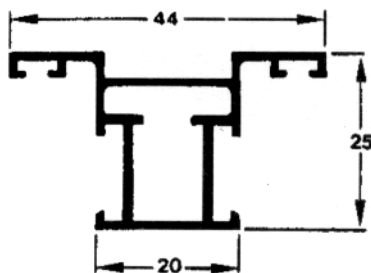

**25-308**

0,455 Kg/m

Travessa

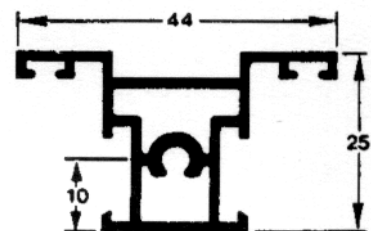

**MM-376**

0,523 Kg/m

Travessa

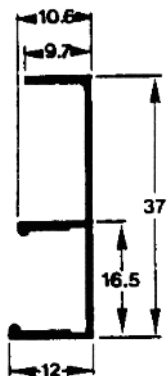

Remate Clicado



**20-347**

0,182 Kg/m

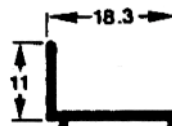

**MP-073**  
0,105 Kg/m  
Porta Palheta

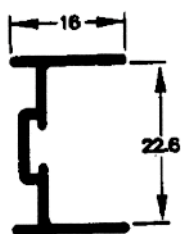

**MP-352**  
0,200 Kg/m  
Remate Lateral

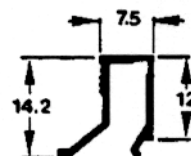

**BG-202**  
0,108 Kg/m  
Baguete

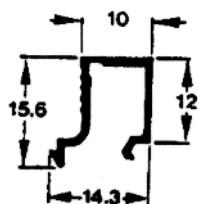

**BG-035**  
0,122 Kg/m  
Baguete

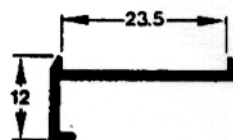

**MM-377**  
0,130 Kg/m  
Recobridor da Folha

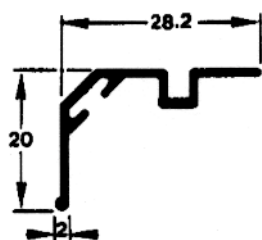

**ME-056**  
0,195 Kg/m  
Pingadeira

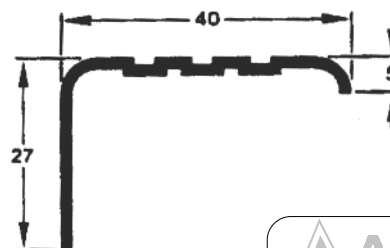

Remate  
do Trilho



**ME-013**

0,265 Kg/m

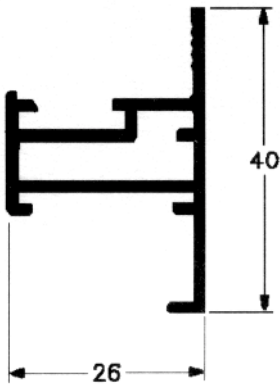

**MM-375/25304**  
0,417 Kg/m

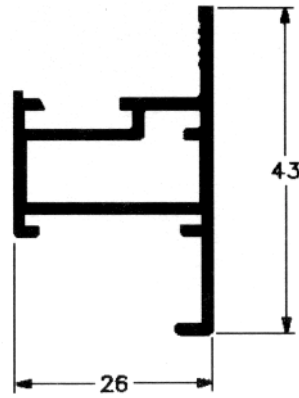

**25-315**  
0,434 Kg/m

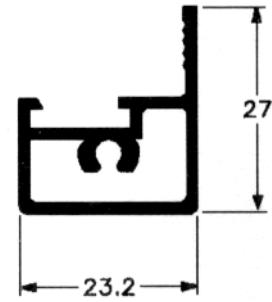

**25-301**  
0,350 Kg/m

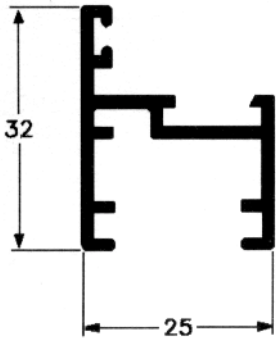

**25-311**  
0,300 Kg/m

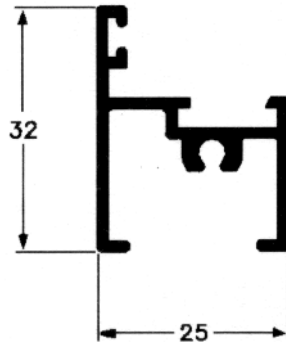

**25-312**  
0,352 Kg/m

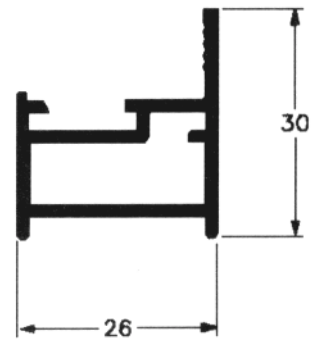

**25-314**  
0,363 Kg/m

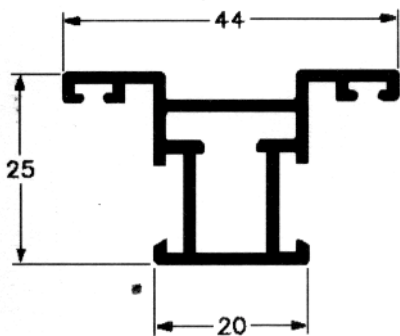

**25-308**  
0,455 Kg/m

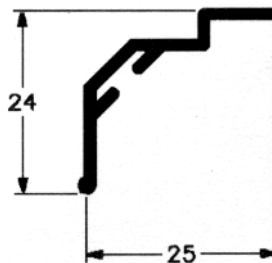

**25-307**  
0,171 Kg/m

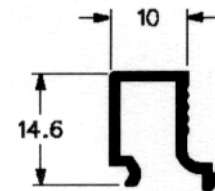

**BG-035**  
0,122 Kg/m

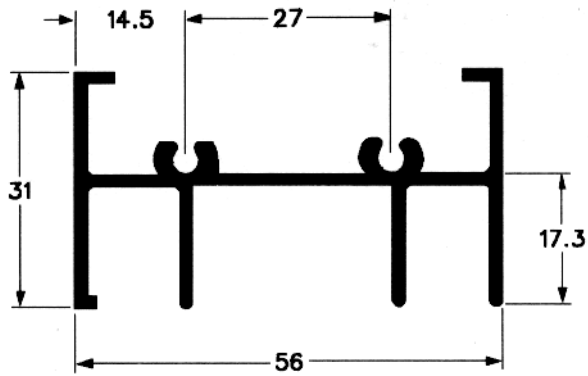

**MP-342**  
0,655 Kg/m

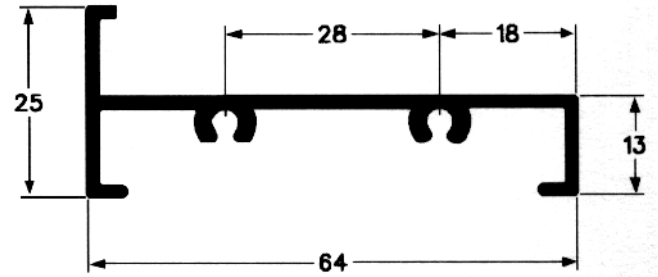

**MP-389**  
0,477 Kg/m

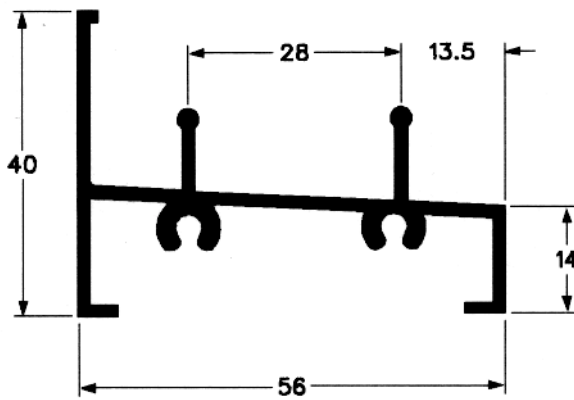

**MP-343**  
0,634 Kg/m

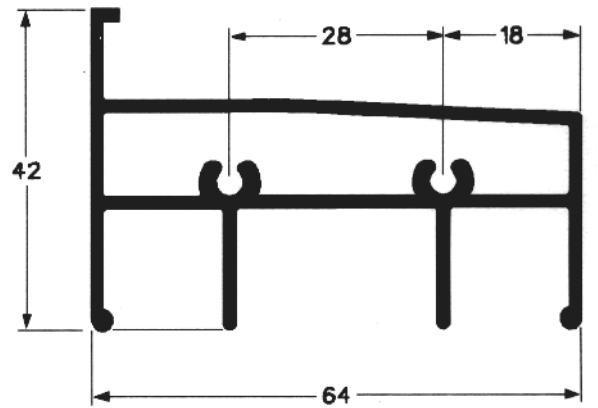

**MP-388**  
0,905 Kg/m